

Great Power Polymer Li-ion Rechargeable Battery

Product Specifications-GSP041530

Model		GSP 041530	
Specifications		3.7V/ 120mAh	
Nominal voltage	3.7V	Cut-off voltage	3.0V
Capacity	120mAh(@0.5C discharge, 23°C)		
Impedance	200m		
Cycle Life	500 Cycles (@0.5C charge&discharge, 23°C)		
Self-discharge	Residual capacity > 90% (@25°C±2°C, 30 days)		
Max. charge current	1C (120mA)		
Max.discharge current	1C (120mA)		
Operating temperature	Charging	0 °C ~ 45 °C	
	Discharging	-20 °C ~ 60 °C	
	Storage	-20 °C ~ 45 °C	
Dimensions /mm	L	30.0 ± 1.0	
	W	15.0 ± 0.5	
	H	4.0 ± 0.2	
	L ₁	10.0 ± 1.0	
	W ₁	3	
	W ₂	6.0 ± 1.0	
Cell Weight(Approx.)		2.5g	

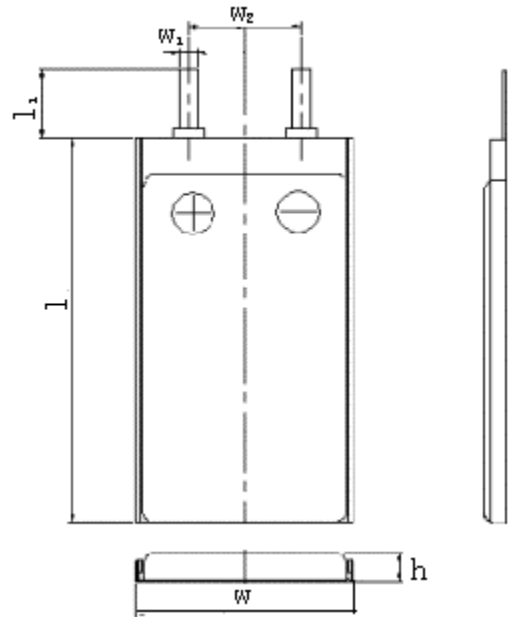

Great Power Polymer Li-ion Rechargeable Battery

Product Specifications-GSP041530

1. Charge Characteristics

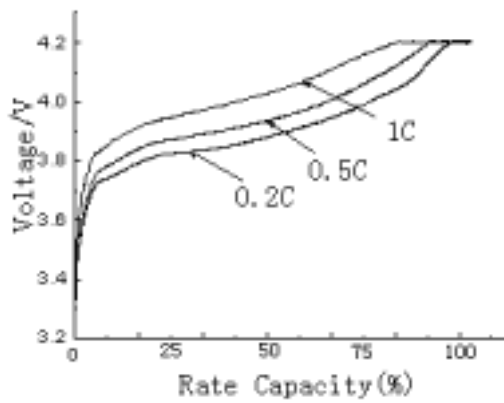

2. Discharge Characteristics

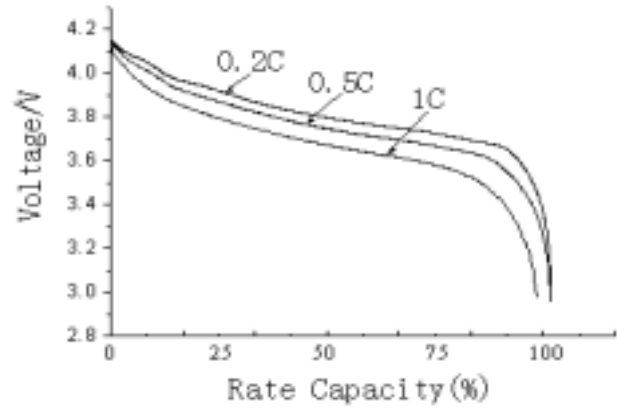

3. Discharge Temperature Characteristics

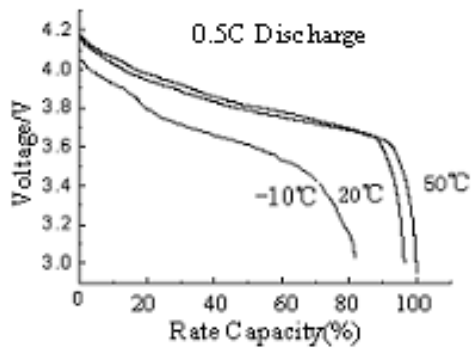

4. Cycle life

